

Accessories for

SF29 PVC

Contents

1. Connectors	02
1.1 IP67 Injection-moulded Connector	
1.2 IP68 Dual Injection-moulded Connector	
1.3 DIY Connector	
1.4 On Cable Waterproof connector	
2. Mounting Profile	06
2.1 Standard Aluminum Profile	
2.2 Self Locking Aluminum Profile	
2.3 Bounce Locking Aluminum Profile	
2.4 Bendable Stainless Steel Profile	
3. Packaging	07

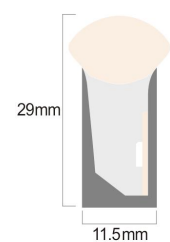
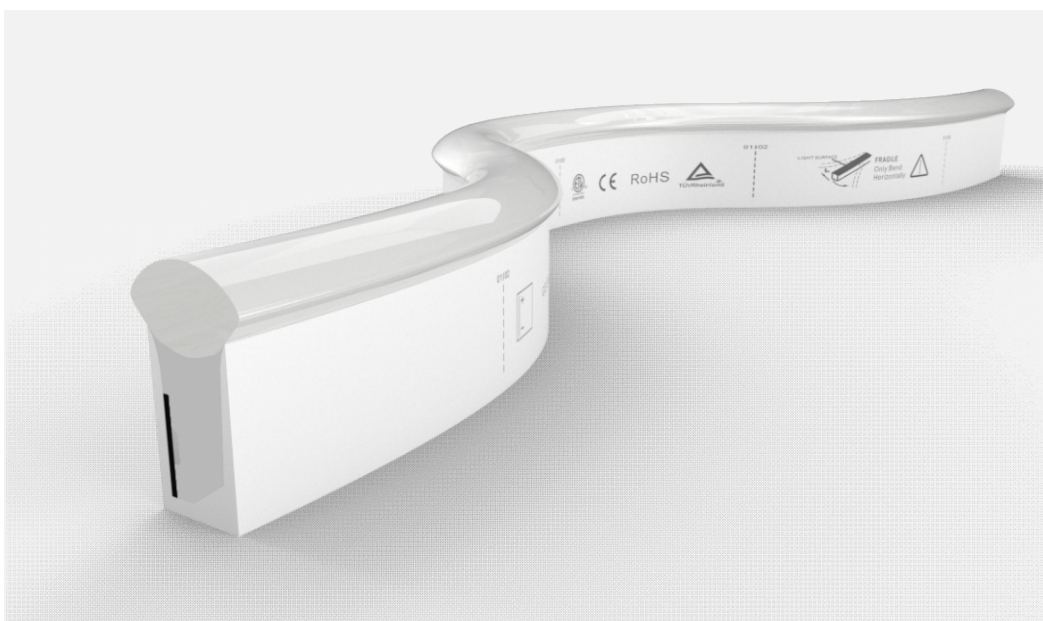

1. Connectors

1.1 IP67 Injection-moulded Connector

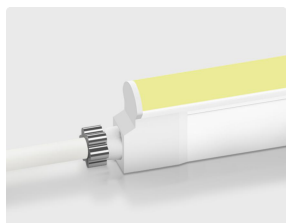

Injection-moulded Front Connector (Direct)
SF29-IM-D

Factory Pre-installed
Cable Output: direct
Standard Cable Length: 0.5m/1m/2m/3m

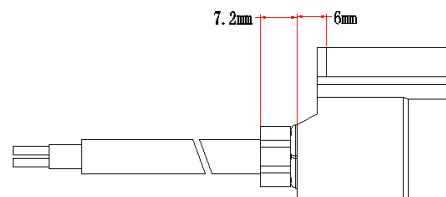
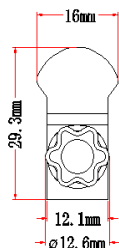

Injection-moulded Front Connector (Side)
SF29-IM-S

Factory Pre-installed
Cable Output: side
Standard Cable Length: 0.5m/1m/2m/3m

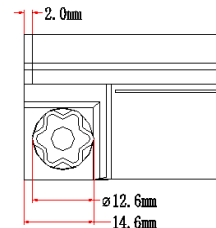
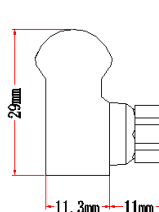

Injection-moulded Front Connector (Bottom)
SF29-IM-B

Factory Pre-installed
Cable Output: bottom
Standard Cable Length: 0.5m/1m/2m/3m

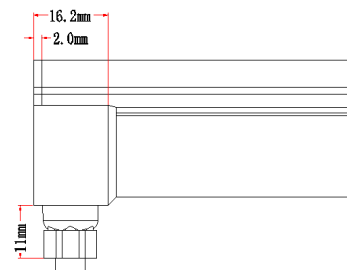
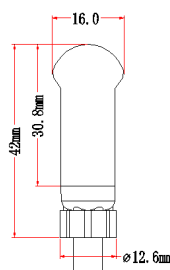

Injection-moulded Middle Connector
SF29-IM-MC

Factory Pre-installed
Cable Output: side
Standard Cable Length: 0.5m/1m/2m/3m

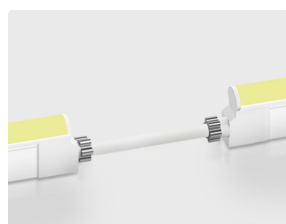
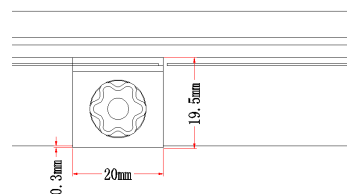
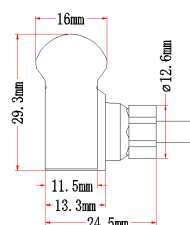

Injection-moulded Middle Jumper
SF29-IM-MJ

Factory Pre-installed
Cable Output: direct
Standard Cable Length: 0.2m~2m

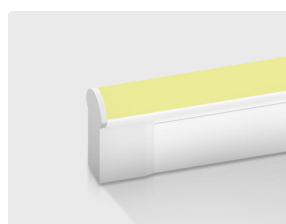
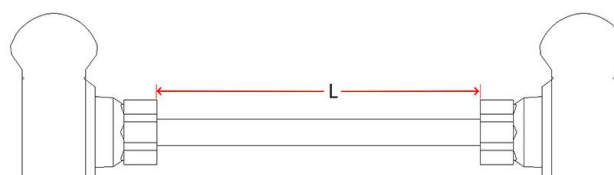

Injection-moulded End Cap
SF29-IM-EC

Factory Pre-installed

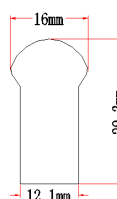

1. Connectors

1.2 IP68 Dual Injection-moulded Connector

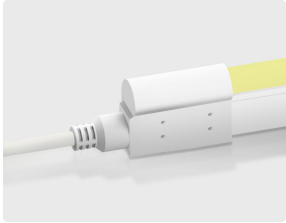

Dual Injection-moulded Front Connector (Direct)
SF29-DI-D

Factory Pre-installed
Cable Output: direct
Standard Cable Length: 0.5m/1m/2m/3m

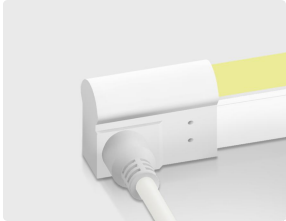
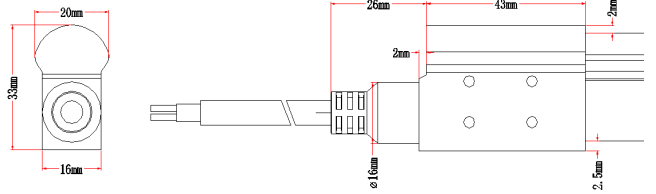

Dual Injection-moulded Front Connector (Side)
SF29-DI-S

Factory Pre-installed
Cable Output: side
Standard Cable Length: 0.5m/1m/2m/3m

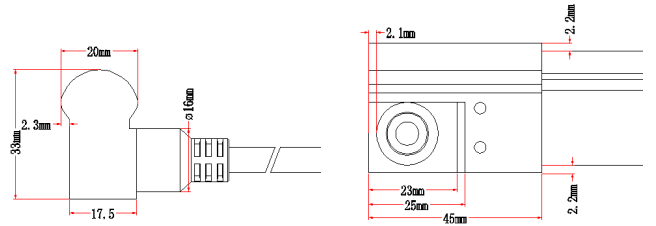

Dual Injection-moulded Front Connector (Bottom)
SF29-DI-B

Factory Pre-installed
Cable Output: bottom
Standard Cable Length: 0.5m/1m/2m/3m

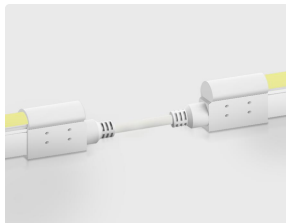
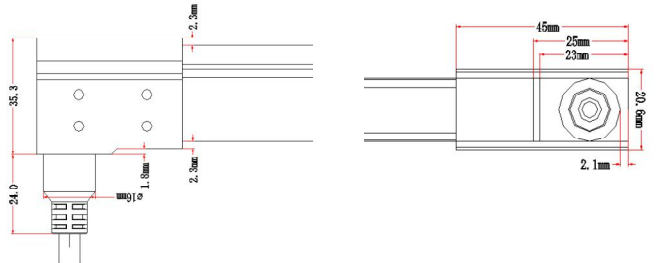

Dual Injection-moulded Middle Jumper
SF29-DI-MJ

Factory Pre-installed
Cable Output: direct
Standard Cable Length: 0.2m~2m

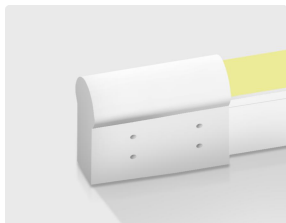

Dual Injection-moulded End Cap
SF29-DI-EC

Factory Pre-installed

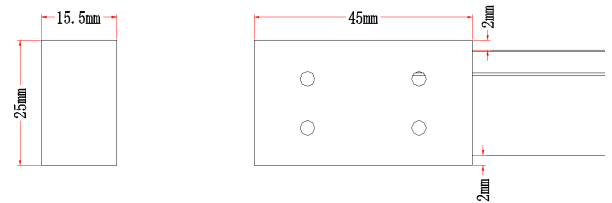

Note: Submersible ≤2m

1. Connectors

1.3 DIY Connector



IP67 Sleeve Front Connector (Direct)
SF29-SL-D

DIY type, can be installed on site
Cable Output: direct
Standard Cable Length: 0.5m/1m/2m/3m

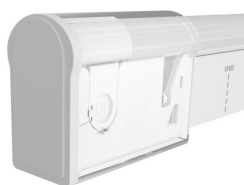
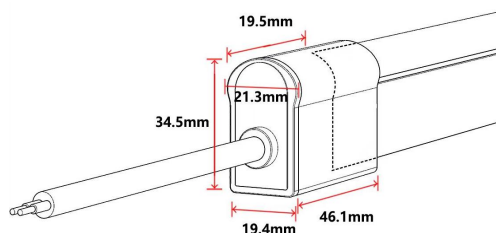

IP67 Sleeve End Cap
SF29-SL-EC

DIY type, can be installed on site

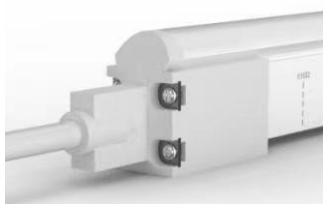
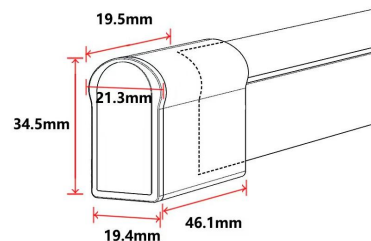

IP68 Screw Front Connector (Direct)
SF29-SC-D

DIY type, can be installed on site
Cable Output: direct
Standard Cable Length: 0.5m/1m/2m/3m

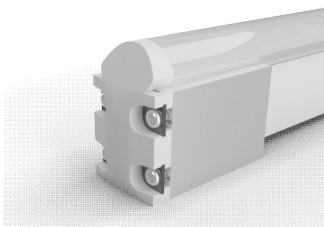
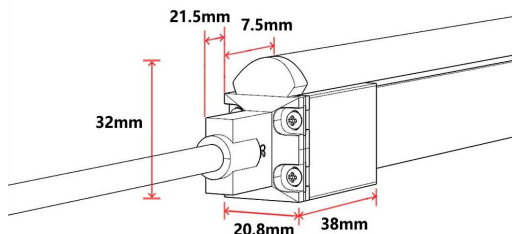

IP68 Screw End Cap
SF29-SC-EC

DIY type, can be installed on site

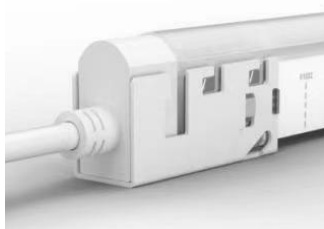
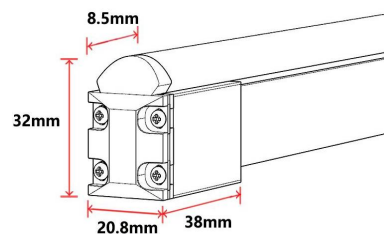

IP65 Clasp Front Connector (Direct)
SF29-CL-D

DIY type, can be installed on site
Cable Output: direct
Standard Cable Length: 0.5m/1m/2m/3m

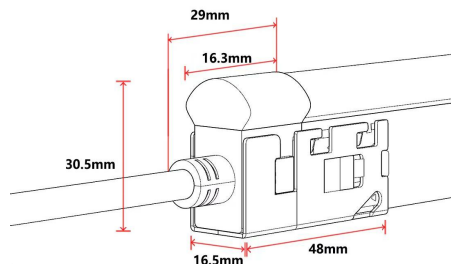

IP65 Clasp End Cap
SF29-CL-EC

DIY type, can be installed on site

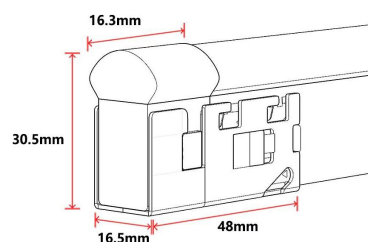

1. Connectors

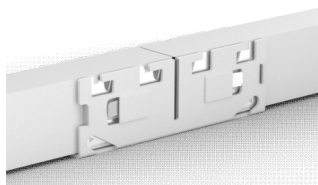

IP65 Seamless Middle Connector
SF29-CL-MC

DIY type, can be installed on site
Cable Output: direct
Standard Cable Length: 0.2m~2m

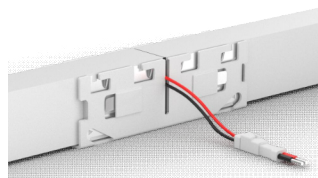
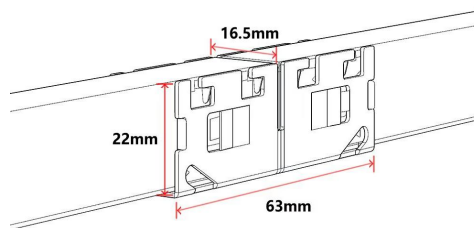

IP65 Seamless Power T-Feed
SF29-CL-MTF

DIY type, can be installed on site
Cable Output: side
Standard Cable Length: 0.2m~2m

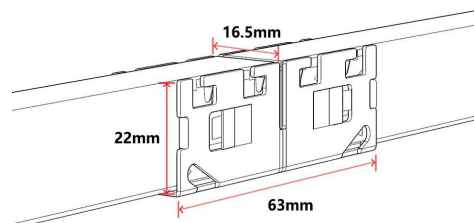

1.4 On Cable Waterproof Connector

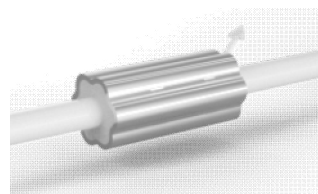

Waterproof Interrupter

The waterproof interrupter is installed on the cable at 120mm from the front connector, which protect against water ingress from inside of cable

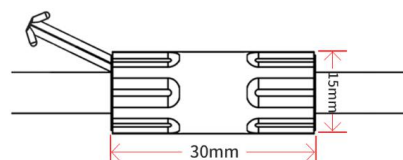

Male & Female Connector
CT01

DIY or Pre-installed, IP67
Stand Cable Length: 0.5m/1m/2m/3m
Cable Diameter: Ø6.0mm

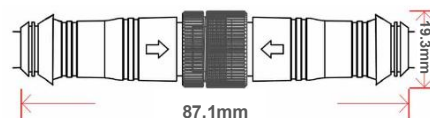

Male & Female Connector
CT02

DIY or Pre-installed, IP68 /IP67 optional

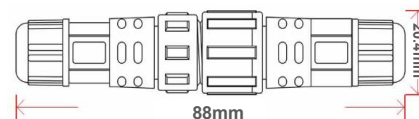

Note: For all DIY connectors, installation on site will void warranty regarding waterproof.

2. Mounting Profile

2.1 Standard Aluminum Profile ▼

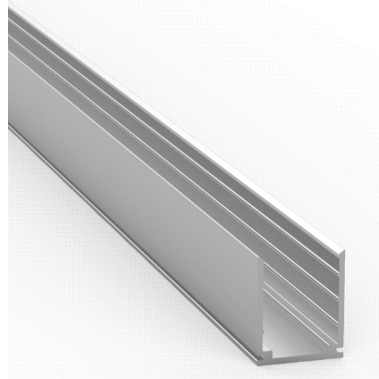

Max. Installation Angle

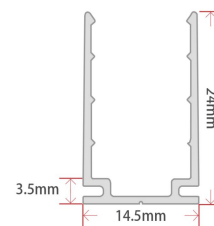
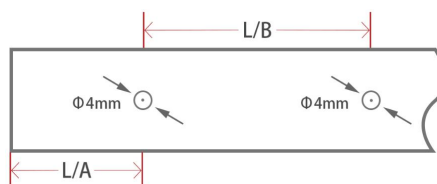

W*H	Model	Standard Length	Hole Number	Screw Hole	L/A (mm)	L/B (mm)	For Product
14.5x24mm	ALC-N-SF29-50	50mm	1	Φ4.0mm	25.5	/	SF29 / SFS29
	ALC-N-SF29-1000	1000mm	2	Φ4.0mm	20	60	SF29 / SFS29
	ALC-N-SF29-2000	2000mm	4	Φ4.0mm	25	50	SF29 / SFS29

2.2 Self Locking Aluminum Profile ▼

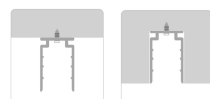
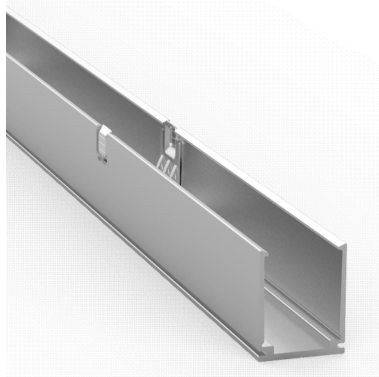

Max. Installation Angle

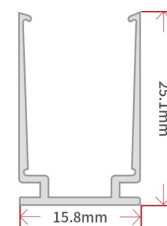
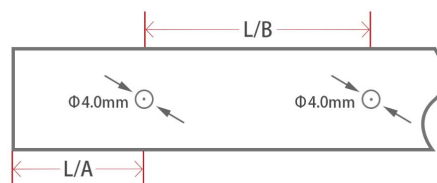

W*H	Model	Standard Length	Hole Number	Screw Hole	L/A (mm)	L/B (mm)	For Product
15.8x25.1mm	ALC-SL-SF29-50	50mm	1	Φ4.0mm	25.5	/	SF29 / SFS29
	ALC-SL-SF29-1000	1000mm	2	Φ4.0mm	20	60	SF29 / SFS29
	ALC-SL-SF29-2000	2000mm	4	Φ4.0mm	25	50	SF29 / SFS29

2.3 Bounce Locking Aluminum Profile ▼

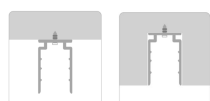

Max. Installation Angle

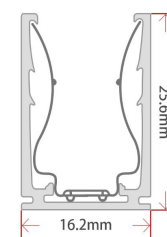
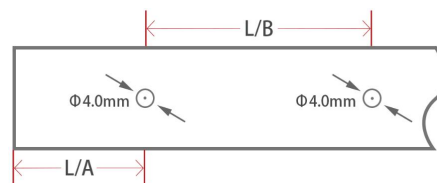

W*H	Model	Standard Length	Hole Number	Screw Hole	L/A (mm)	L/B (mm)	For Product
16.2x25.6mm	ALC-BL-SF29-50	50mm	1	Φ4.0mm	25.5	/	SF29 / SFS29
	ALC-BL-SF29-1000	1000mm	2	Φ4.0mm	20	60	SF29 / SFS29
	ALC-BL-SF29-2000	2000mm	4	Φ4.0mm	25	50	SF29 / SFS29

2. Mounting Profile

2.4 Bendable Stainless Steel Profile ▼

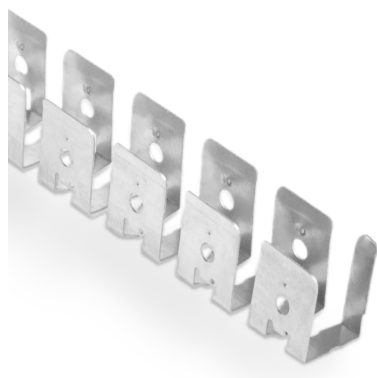

Max. Installation Angle

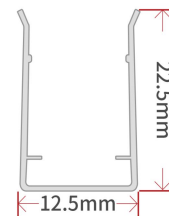
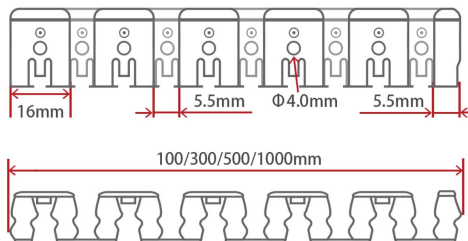

W*H	Model	Standard Length	For Product
12.5x22.5mm	ALC-SL-SF29-100	100mm	SF29 / SFS29
	ALC-SL-SF29-300	300mm	SF29 / SFS29
	ALC-SL-SF29-500	500mm	SF29 / SFS29
	ALC-SL-SF29-1000	1000mm	SF29 / SFS29

3. Packaging

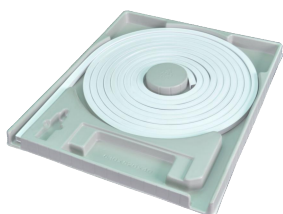

Blister Plate



White Box



Carton



Carton



M Reel



L Reel



Carton



Carton

Neon Length	Packing Method	White Box Dimension	Carton Dimension	White Box Numbers	Carton Weight
Max. 1m	S Blister Plate + White Box	31x31x4.5cm	/	/	≤0.7kg
Max. 6m	M Blister Plate + White Box + Carton	40x50x4.5cm	41x51x25cm	5	≤15kg
Max. 11m	L Blister Plate + White Box + Carton	54x64x4.5cm	55x65x25cm	5	≤26.7kg
Max. 20m	XL Blister Plate + White Box + Carton	68x79x4.5cm	69x80x15.5cm	2	≤17.5kg
Max. 50m	L Reel + Carton	Φ45x25cm	47x47x28cm	1	≤21.3kg